

Origami Geldschein Faltsymbole – Allgemein Erläuterungen

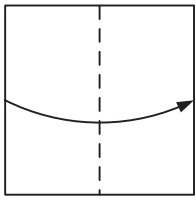

Talfalte

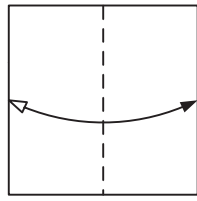

Talfalten und wieder Auffalten

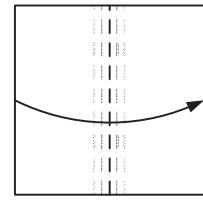
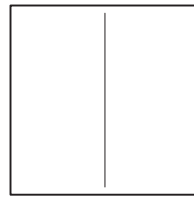

Variable Talfalte (T-up2you)

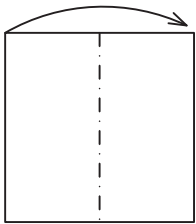

Bergfalte

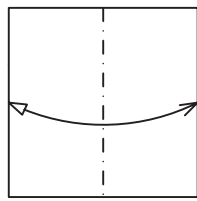

Bergfalten und wieder Auffalten

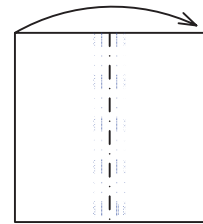
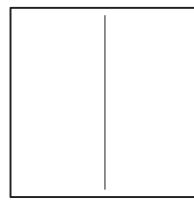

Variable Bergfalte (M-up2you)

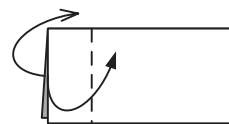
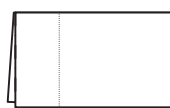
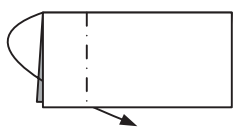
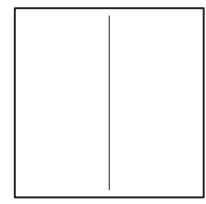
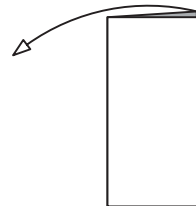
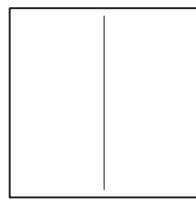
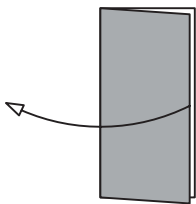

Nach außen zurückfalten

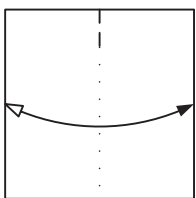

Markierungslinie

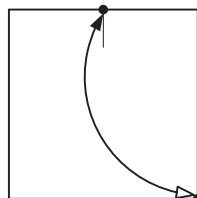

Markierungspunkte

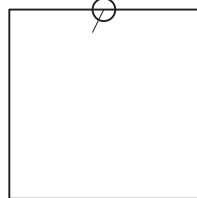

Hinweiskreis

08-09

Faltschritt(e) mit der angegebenen Nummer wiederholen

Papier umdrehen



nach rechts



nach links



nach oben



nach unten

Papier um die angegebene Winkelzahl drehen



nach rechts



nach links

Origami Geldschein CEWE-Hemd

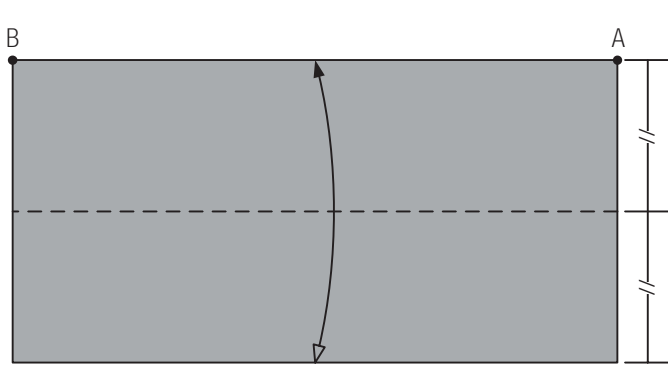

1. Talfalten Sie die untere Kante auf die obere Kante und falten Sie den Geldschein wieder auf.



2. Talfalten Sie die linke und die rechte Kante nach vorne. Die rechte Kante ist um die Hälfte kleiner als die linke Kante.

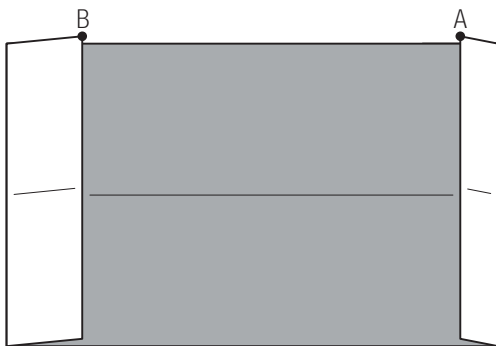

3. Drehen Sie den Geldschein um.

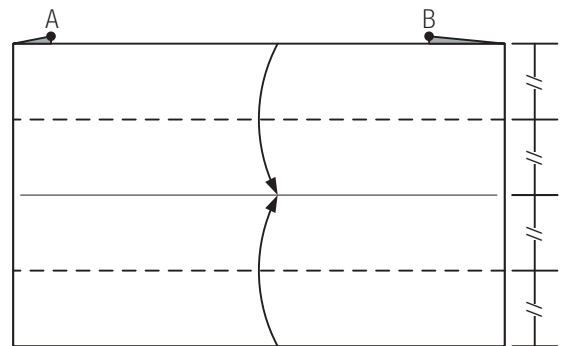

4. Talfalten Sie nun die untere und obere Kante auf die Mitte.

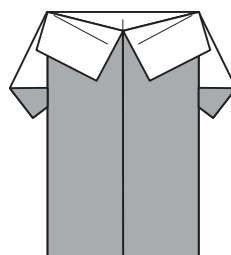
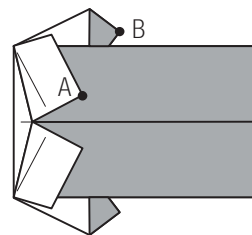
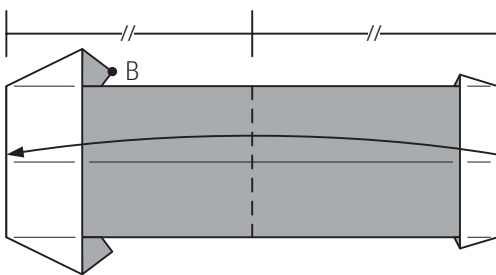
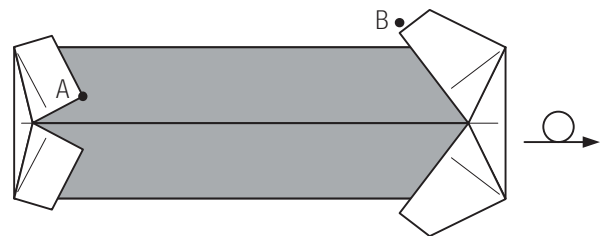
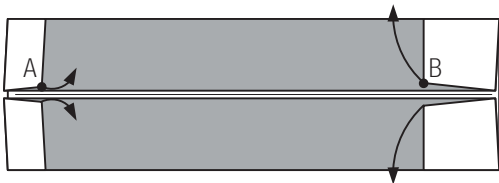

FERTIG!

Origami Geldschein CEWE-Kleid

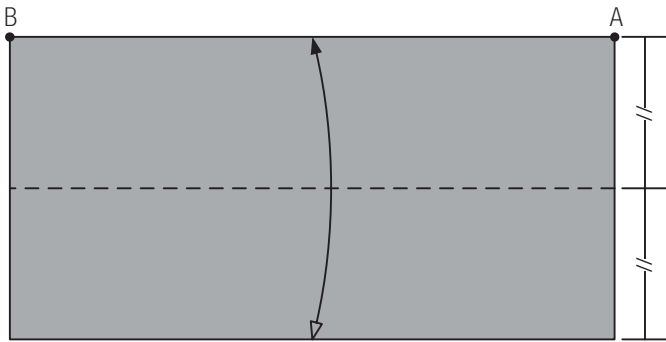

1. Tal falten Sie die untere Kante auf die obere Kante und falten Sie den Geldschein wieder auf.

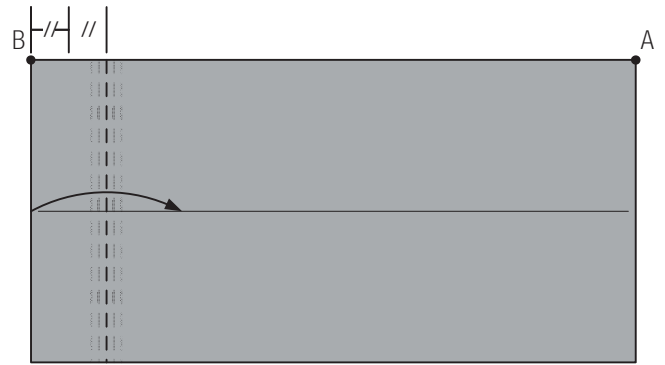

2. Tal falten Sie die linke Kante nach vorne.



3. Drehen Sie den Geldschein um.

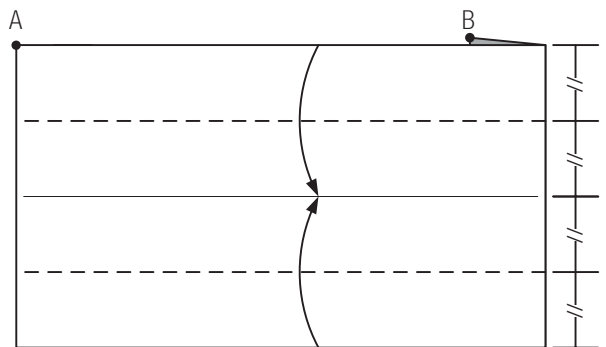

4. Tal falten Sie nun die untere und obere Kante auf die Mitte.



5. Ziehen Sie nun die zwei rechten Ecken leicht in Pfeilrichtung und drücken Sie den Geldschein flach.

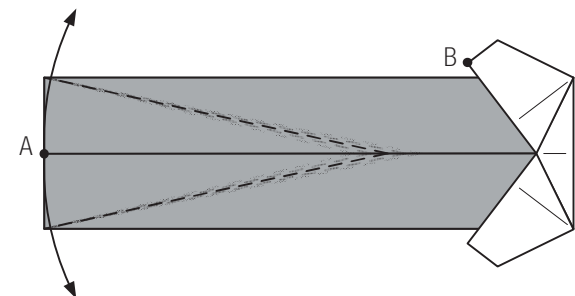

6. Tal falten Sie die rechten oberen Lagen nach oben bzw. nach unten.

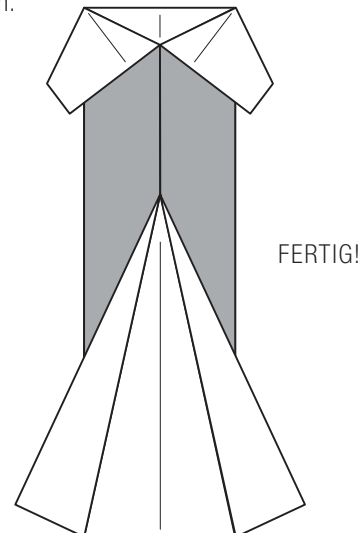
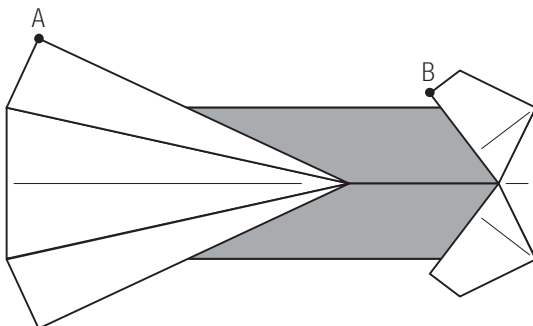

Origami Geldschein CEWE-Herz

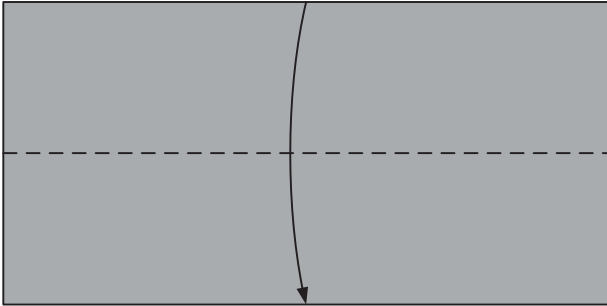

1. Talfalten Sie die obere Kante auf die unter Kante.



2. Talfalten Sie die rechte Kante auf die linke Kante.

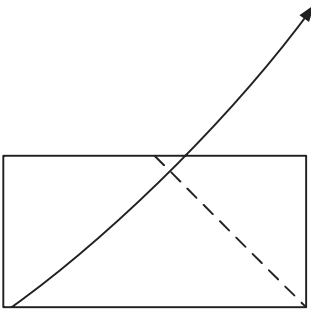

3. Talfalten Sie die obere Lage vom Geldschein nach oben, sodass die unter Kante die rechte Kante berührt.

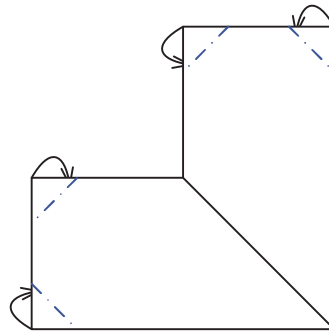

4. Bergfalten Sie die vier Ecken nach hinten.

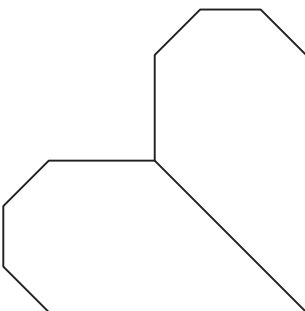

5. Drehen Sie das Herz.

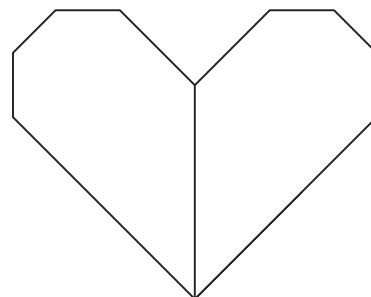

FERTIG!